

MUN5211DW1T1 Series

Preferred Devices

Dual Bias Resistor Transistors

NPN Silicon Surface Mount Transistors with Monolithic Bias Resistor Network

The BRT (Bias Resistor Transistor) contains a single transistor with a monolithic bias network consisting of two resistors; a series base resistor and a base-emitter resistor. These digital transistors are designed to replace a single device and its external resistor bias network. The BRT eliminates these individual components by integrating them into a single device. In the MUN5211DW1T1 series, two BRT devices are housed in the SOT-363 package which is ideal for low power surface mount applications where board space is at a premium.

Features

- Simplifies Circuit Design
- Reduces Board Space
- Reduces Component Count
- Pb-Free Packages are Available

MAXIMUM RATINGS

($T_A = 25^\circ\text{C}$ unless otherwise noted, common for Q_1 and Q_2)

Rating	Symbol	Value	Unit
Collector-Base Voltage	V_{CBO}	50	Vdc
Collector-Emitter Voltage	V_{CEO}	50	Vdc
Collector Current	I_C	100	mAdc

THERMAL CHARACTERISTICS

Characteristic (One Junction Heated)	Symbol	Max	Unit
Total Device Dissipation $T_A = 25^\circ\text{C}$ Derate above 25°C	P_D	187 (Note 1) 256 (Note 2) 1.5 (Note 1) 2.0 (Note 2)	mW mW/ $^\circ\text{C}$
Thermal Resistance, Junction-to-Ambient	$R_{\theta JA}$	670 (Note 1) 490 (Note 2)	$^\circ\text{C}/\text{W}$
Characteristic (Both Junctions Heated)	Symbol	Max	Unit
Total Device Dissipation $T_A = 25^\circ\text{C}$ Derate above 25°C	P_D	250 (Note 1) 385 (Note 2) 2.0 (Note 1) 3.0 (Note 2)	mW mW/ $^\circ\text{C}$
Thermal Resistance, Junction-to-Ambient	$R_{\theta JA}$	493 (Note 1) 325 (Note 2)	$^\circ\text{C}/\text{W}$
Thermal Resistance, Junction-to-Lead	$R_{\theta JL}$	188 (Note 1) 208 (Note 2)	$^\circ\text{C}/\text{W}$
Junction and Storage Temperature	T_J, T_{stg}	-55 to +150	$^\circ\text{C}$

Maximum ratings are those values beyond which device damage can occur. Maximum ratings applied to the device are individual stress limit values (not normal operating conditions) and are not valid simultaneously. If these limits are exceeded, device functional operation is not implied, damage may occur and reliability may be affected.

1. FR-4 @ Minimum Pad
2. FR-4 @ 1.0 x 1.0 inch Pad



ON Semiconductor®

<http://onsemi.com>

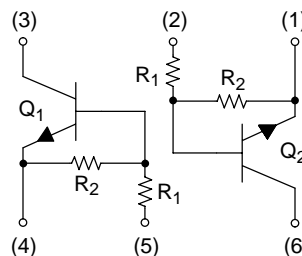

SOT-363
CASE 419B
STYLE 1

MARKING DIAGRAM

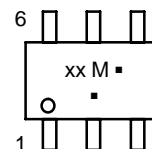

- xx = Device Code
- M = Date Code*
- = Pb-Free Package

(Note: Microdot may be in either location)

*Date Code orientation and/or position may vary depending upon manufacturing location.

DEVICE MARKING INFORMATION

See specific marking information in the device marking table on page 2 of this data sheet.

Preferred devices are recommended choices for future use and best overall value.

MUN5211DW1T1 Series

DEVICE MARKING AND RESISTOR VALUES

Device	Package	Marking	R1 (K)	R2 (K)	Shipping†
MUN5211DW1T1	SOT-363	7A	10	10	3000/Tape & Reel
MUN5211DW1T1G	SOT-363 (Pb-Free)	7A	10	10	3000/Tape & Reel
MUN5212DW1T1	SOT-363	7B	22	22	3000/Tape & Reel
MUN5212DW1T1G	SOT-363 (Pb-Free)	7B	22	22	3000/Tape & Reel
MUN5213DW1T1	SOT-363	7C	47	47	3000/Tape & Reel
MUN5213DW1T1G	SOT-363 (Pb-Free)	7C	47	47	3000/Tape & Reel
MUN5214DW1T1	SOT-363	7D	10	47	3000/Tape & Reel
MUN5214DW1T1G	SOT-363 (Pb-Free)	7D	10	47	3000/Tape & Reel
MUN5215DW1T1	SOT-363	7E	10	∞	3000/Tape & Reel
MUN5215DW1T1G	SOT-363 (Pb-Free)	7E	10	∞	3000/Tape & Reel
MUN5216DW1T1	SOT-363	7F	4.7	∞	3000/Tape & Reel
MUN5216DW1T1G	SOT-363 (Pb-Free)	7F	4.7	∞	3000/Tape & Reel
MUN5230DW1T1	SOT-363	7G	1.0	1.0	3000/Tape & Reel
MUN5230DW1T1G	SOT-363 (Pb-Free)	7G	1.0	1.0	3000/Tape & Reel
MUN5231DW1T1	SOT-363	7H	2.2	2.2	3000/Tape & Reel
MUN5231DW1T1G	SOT-363 (Pb-Free)	7H	2.2	2.2	3000/Tape & Reel
MUN5232DW1T1	SOT-363	7J	4.7	4.7	3000/Tape & Reel
MUN5232DW1T1G	SOT-363 (Pb-Free)	7J	4.7	4.7	3000/Tape & Reel
MUN5233DW1T1	SOT-363	7K	4.7	47	3000/Tape & Reel
MUN5233DW1T1G	SOT-363 (Pb-Free)	7K	4.7	47	3000/Tape & Reel
MUN5234DW1T1	SOT-363	7L	22	47	3000/Tape & Reel
MUN5234DW1T1G	SOT-363 (Pb-Free)	7L	22	47	3000/Tape & Reel
MUN5235DW1T1	SOT-363	7M	2.2	47	3000/Tape & Reel
MUN5235DW1T1G	SOT-363 (Pb-Free)	7M	2.2	47	3000/Tape & Reel
MUN5236DW1T1	SOT-363	7N	100	100	3000/Tape & Reel
MUN5236DW1T1G	SOT-363 (Pb-Free)	7N	100	100	3000/Tape & Reel
MUN5237DW1T1	SOT-363	7P	47	22	3000/Tape & Reel
MUN5237DW1T1G	SOT-363 (Pb-Free)	7P	47	22	3000/Tape & Reel

†For information on tape and reel specifications, including part orientation and tape sizes, please refer to our Tape and Reel Packaging Specifications Brochure, BRD8011/D.

MUN5211DW1T1 Series

ELECTRICAL CHARACTERISTICS ($T_A = 25^\circ\text{C}$ unless otherwise noted, common for Q_1 and Q_2)

Characteristic	Symbol	Min	Typ	Max	Unit
OFF CHARACTERISTICS					
Collector-Base Cutoff Current ($V_{CB} = 50\text{ V}$, $I_E = 0$)	I_{CBO}	-	-	100	nAdc
Collector-Emitter Cutoff Current ($V_{CE} = 50\text{ V}$, $I_B = 0$)	I_{CEO}	-	-	500	nAdc
Emitter-Base Cutoff Current ($V_{EB} = 6.0\text{ V}$, $I_C = 0$)	I_{EBO}	-	-	0.5	mAdc
MUN5211DW1T1, G		-	-	0.2	
MUN5212DW1T1, G		-	-	0.1	
MUN5213DW1T1, G		-	-	0.2	
MUN5214DW1T1, G		-	-	0.9	
MUN5215DW1T1, G		-	-	1.9	
MUN5216DW1T1, G		-	-	4.3	
MUN5230DW1T1, G		-	-	2.3	
MUN5231DW1T1, G		-	-	1.5	
MUN5232DW1T1, G		-	-	0.18	
MUN5233DW1T1, G		-	-	0.13	
MUN5234DW1T1, G		-	-	0.2	
MUN5235DW1T1, G		-	-	0.05	
MUN5236DW1T1, G		-	-	0.13	
MUN5237DW1T1, G		-	-		
Collector-Base Breakdown Voltage ($I_C = 10\ \mu\text{A}$, $I_E = 0$)	$V_{(BR)CBO}$	50	-	-	Vdc
Collector-Emitter Breakdown Voltage (Note 3) ($I_C = 2.0\text{ mA}$, $I_B = 0$)	$V_{(BR)CEO}$	50	-	-	Vdc

3. Pulse Test: Pulse Width < 300 μs , Duty Cycle < 2.0%

ON CHARACTERISTICS (Note 4)

DC Current Gain ($V_{CE} = 10\text{ V}$, $I_C = 5.0\text{ mA}$)	h_{FE}	35	60	-	
MUN5211DW1T1, G		60	100	-	
MUN5212DW1T1, G		80	140	-	
MUN5213DW1T1, G		80	140	-	
MUN5214DW1T1, G		160	350	-	
MUN5215DW1T1, G		160	350	-	
MUN5216DW1T1, G		3.0	5.0	-	
MUN5230DW1T1, G		8.0	15	-	
MUN5231DW1T1, G		15	30	-	
MUN5232DW1T1, G		80	200	-	
MUN5233DW1T1, G		80	150	-	
MUN5234DW1T1, G		80	140	-	
MUN5235DW1T1, G		80	150	-	
MUN5236DW1T1, G		80	140	-	
MUN5237DW1T1, G		80	140	-	

MUN5211DW1T1 Series

Collector-Emitter Saturation Voltage ($I_C = 10 \text{ mA}$, $I_B = 0.3 \text{ mA}$) ($I_C = 10 \text{ mA}$, $I_B = 5 \text{ mA}$) ($I_C = 10 \text{ mA}$, $I_B = 1 \text{ mA}$)	MUN5211DW1T1, G	$V_{CE(sat)}$	-	-	0.25	Vdc
	MUN5212DW1T1, G		-	-	0.25	
	MUN5213DW1T1, G		-	-	0.25	
	MUN5214DW1T1, G		-	-	0.25	
	MUN5235DW1T1, G		-	-	0.25	
	MUN5236DW1T1, G		-	-	0.25	
	MUN5230DW1T1, G		-	-	0.25	
	MUN5231DW1T1, G		-	-	0.25	
	MUN5237DW1T1, G		-	-	0.25	
	MUN5215DW1T1, G		-	-	0.25	
	MUN5216DW1T1, G		-	-	0.25	
	MUN5232DW1T1, G		-	-	0.25	
	MUN5233DW1T1, G		-	-	0.25	
	MUN5234DW1T1, G		-	-	0.25	
Output Voltage (on) ($V_{CC} = 5.0 \text{ V}$, $V_B = 2.5 \text{ V}$, $R_L = 1.0 \text{ k}\Omega$) ($V_{CC} = 5.0 \text{ V}$, $V_B = 3.5 \text{ V}$, $R_L = 1.0 \text{ k}\Omega$) ($V_{CC} = 5.0 \text{ V}$, $V_B = 5.5 \text{ V}$, $R_L = 1.0 \text{ k}\Omega$) ($V_{CC} = 5.0 \text{ V}$, $V_B = 4.0 \text{ V}$, $R_L = 1.0 \text{ k}\Omega$)	MUN5211DW1T1, G	V_{OL}	-	-	0.2	Vdc
	MUN5212DW1T1, G		-	-	0.2	
	MUN5214DW1T1, G		-	-	0.2	
	MUN5215DW1T1, G		-	-	0.2	
	MUN5216DW1T1, G		-	-	0.2	
	MUN5230DW1T1, G		-	-	0.2	
	MUN5231DW1T1, G		-	-	0.2	
	MUN5232DW1T1, G		-	-	0.2	
	MUN5233DW1T1, G		-	-	0.2	
	MUN5234DW1T1, G		-	-	0.2	
	MUN5235DW1T1, G		-	-	0.2	
	MUN5213DW1T1, G		-	-	0.2	
	MUN5236DW1T1, G		-	-	0.2	
	MUN5237DW1T1, G		-	-	0.2	

4. Pulse Test: Pulse Width < 300 μs , Duty Cycle < 2.0%

MUN5211DW1T1 Series

ELECTRICAL CHARACTERISTICS (T_A = 25°C unless otherwise noted, common for Q₁ and Q₂) (Continued)

Characteristic	Symbol	Min	Typ	Max	Unit	
ON CHARACTERISTICS (Note 5) (Continued)						
Output Voltage (off) (V _{CC} = 5.0 V, V _B = 0.5 V, R _L = 1.0 kΩ)	MUN5211DW1T1, G	4.9	–	–	Vdc	
	MUN5212DW1T1, G	4.9	–	–		
	MUN5213DW1T1, G	4.9	–	–		
	MUN5214DW1T1, G	4.9	–	–		
	MUN5233DW1T1, G	4.9	–	–		
	MUN5234DW1T1, G	4.9	–	–		
	MUN5235DW1T1, G	4.9	–	–		
(V _{CC} = 5.0 V, V _B = 0.050 V, R _L = 1.0 kΩ)	MUN5230DW1T1, G	4.9	–	–		
(V _{CC} = 5.0 V, V _B = 0.25 V, R _L = 1.0 kΩ)	MUN5215DW1T1, G	4.9	–	–		
	MUN5216DW1T1, G	4.9	–	–		
	MUN5231DW1T1, G	4.9	–	–		
	MUN5232DW1T1, G	4.9	–	–		
	MUN5236DW1T1, G	4.9	–	–		
	MUN5237DW1T1, G	4.9	–	–		
Input Resistor	MUN5211DW1T1, G	7.0	10	13		k Ω
	MUN5212DW1T1, G	15.4	22	28.6		
	MUN5213DW1T1, G	32.9	47	61.1		
	MUN5214DW1T1, G	7.0	10	13		
	MUN5215DW1T1, G	7.0	10	13		
	MUN5216DW1T1, G	3.3	4.7	6.1		
	MUN5230DW1T1, G	0.7	1.0	1.3		
	MUN5231DW1T1, G	1.5	2.2	2.9		
	MUN5232DW1T1, G	3.3	4.7	6.1		
	MUN5233DW1T1, G	3.3	4.7	6.1		
	MUN5234DW1T1, G	15.4	22	28.6		
	MUN5235DW1T1, G	1.54	2.2	2.86		
	MUN5236DW1T1, G	70	100	130		
	MUN5237DW1T1, G	32.9	47	61.1		
Resistor Ratio	MUN5211DW1T1, G/MUN5212DW1T1, G/ MUN5213DW1T1, G/MUN5236DW1T1, G MUN5214DW1T1, G MUN5215DW1T1, G/MUN5216DW1T1, G MUN5230DW1T1, G/MUN5231DW1T1, G/MUN5232DW1T1, G MUN5233DW1T1, G MUN5234DW1T1, G MUN5235DW1T1, G MUN5237DW1T1, G	R1/R2	0.8 0.17 – 0.8 0.055 0.38 0.038 1.7	1.0 0.21 – 1.0 0.1 0.47 0.047 2.1	1.2 0.25 – 1.2 0.185 0.56 0.056 2.6	

5. Pulse Test: Pulse Width < 300 μs, Duty Cycle < 2.0%

ALL MUN5211DW1T1 SERIES DEVICES

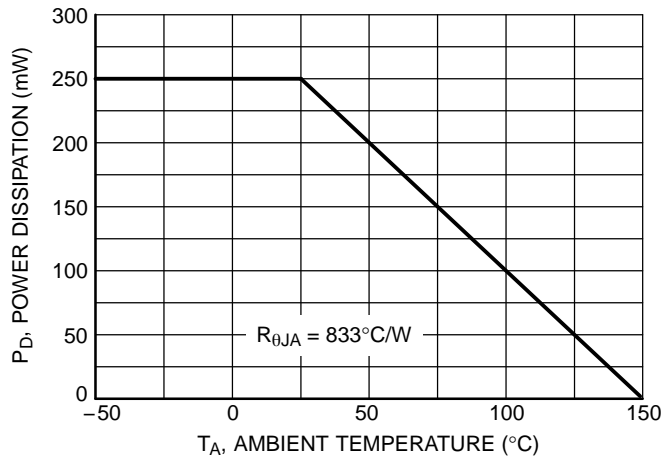

Figure 1. Derating Curve

MUN5211DW1T1 Series

TYPICAL ELECTRICAL CHARACTERISTICS — MUN5211DW1T1

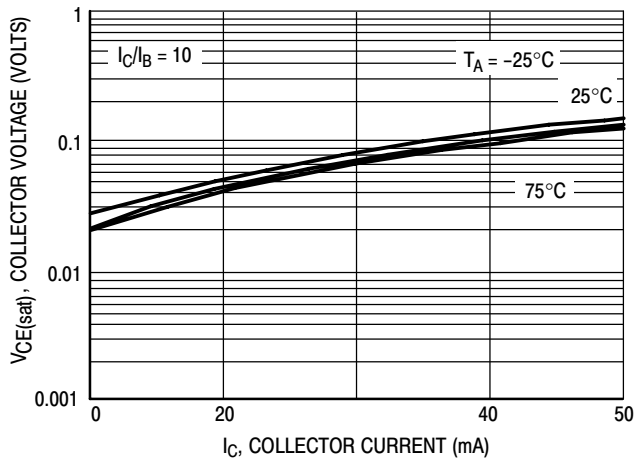

Figure 2. $V_{CE(sat)}$ versus I_C

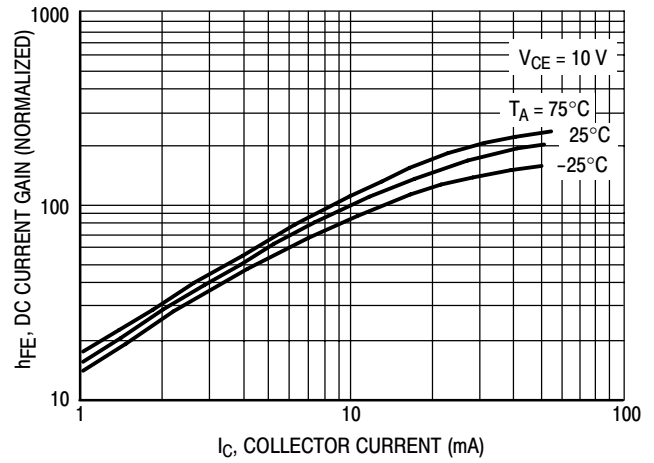

Figure 3. DC Current Gain

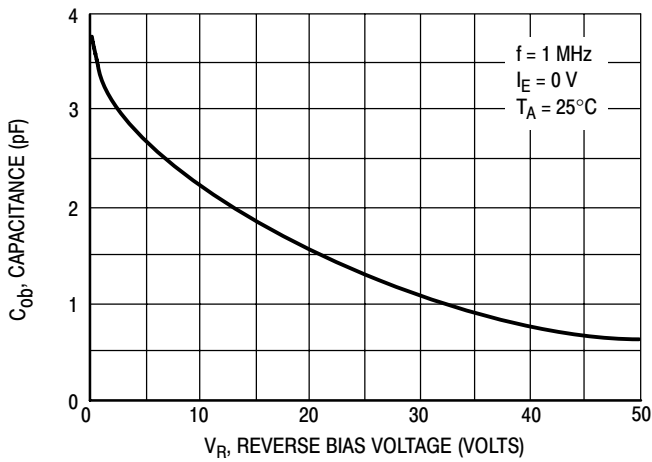

Figure 4. Output Capacitance

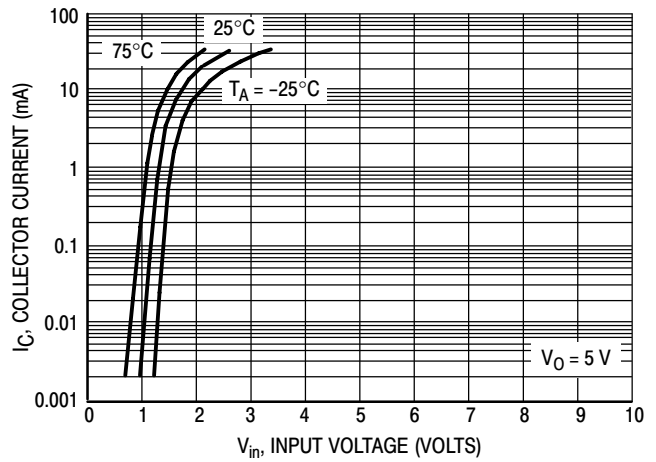

Figure 5. Output Current versus Input Voltage

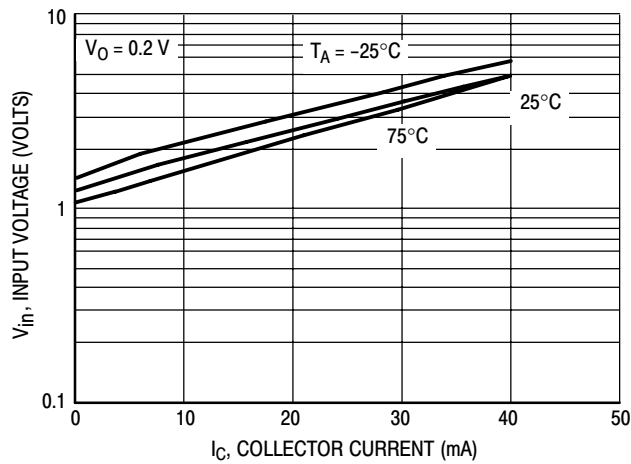

Figure 6. Input Voltage versus Output Current

MUN5211DW1T1 Series

TYPICAL ELECTRICAL CHARACTERISTICS — MUN5212DW1T1

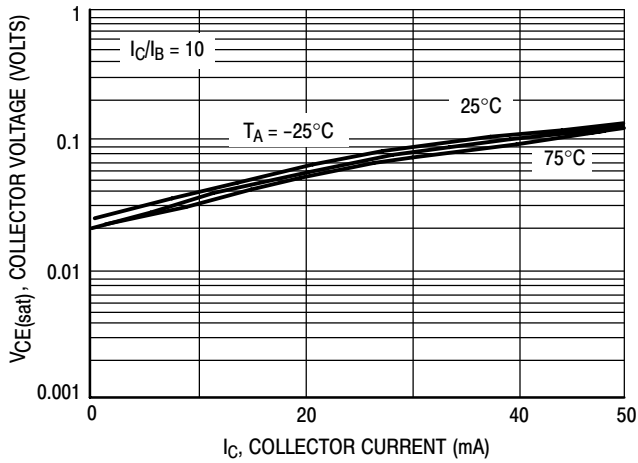

Figure 7. $V_{CE(sat)}$ versus I_C

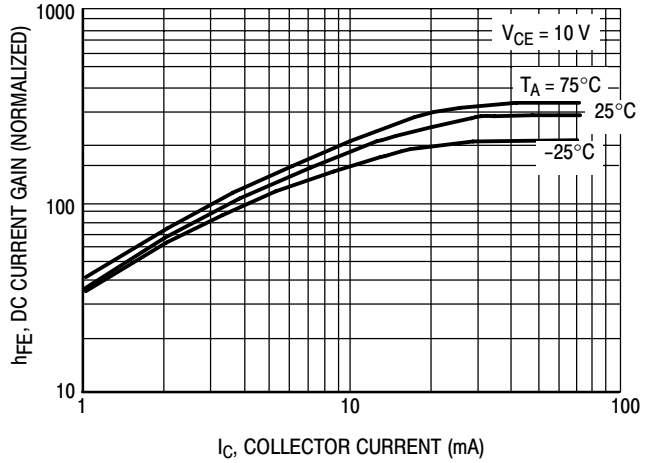

Figure 8. DC Current Gain

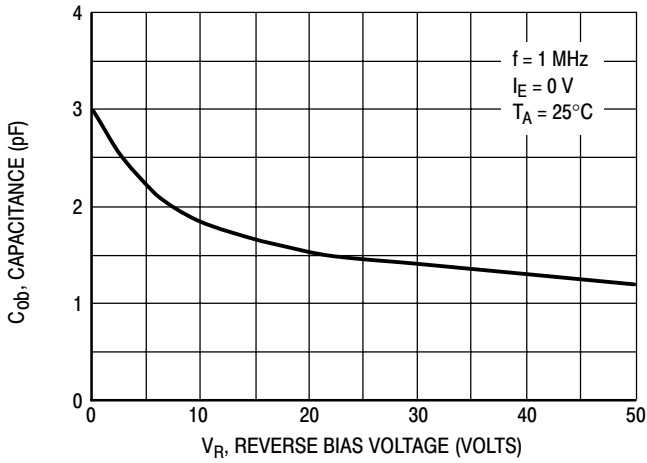

Figure 9. Output Capacitance

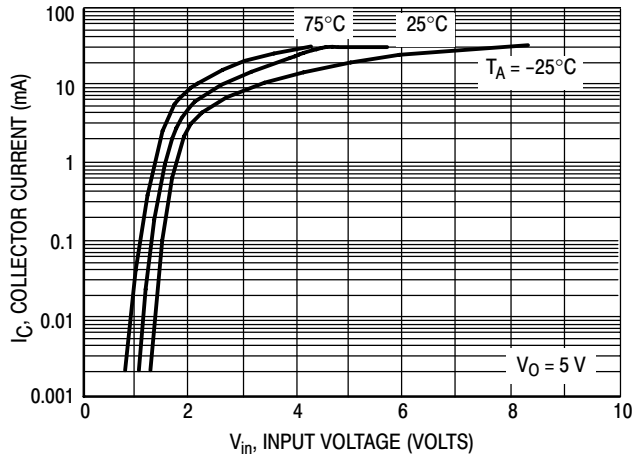

Figure 10. Output Current versus Input Voltage

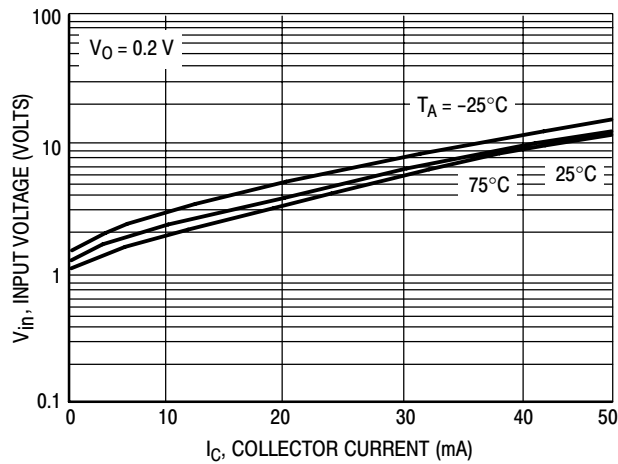

Figure 11. Input Voltage versus Output Current

MUN5211DW1T1 Series

TYPICAL ELECTRICAL CHARACTERISTICS — MUN5213DW1T1

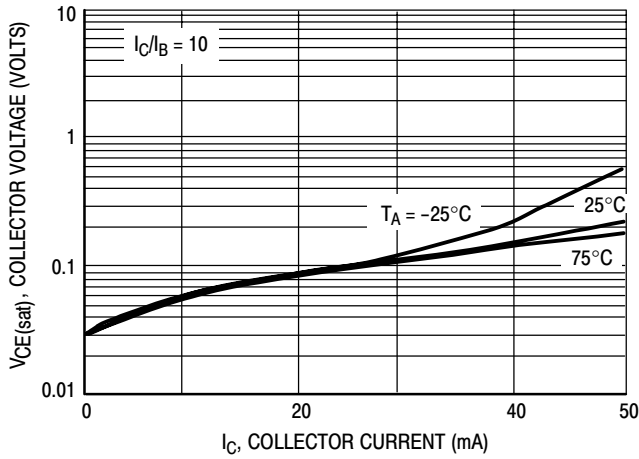

Figure 12. $V_{CE(sat)}$ versus I_C

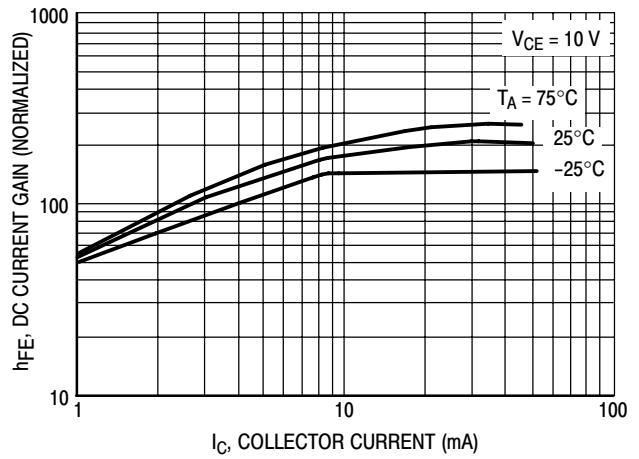

Figure 13. DC Current Gain

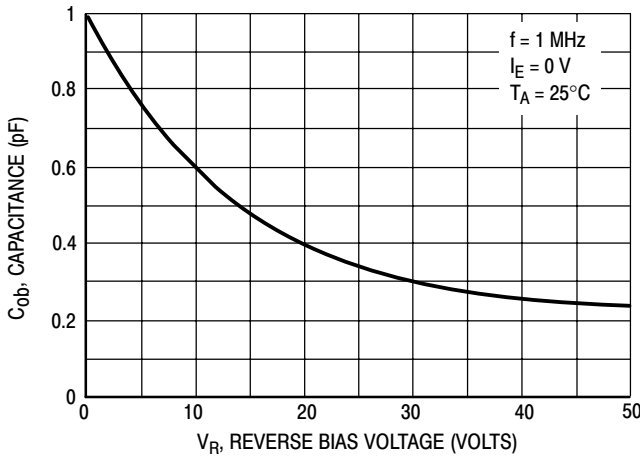

Figure 14. Output Capacitance

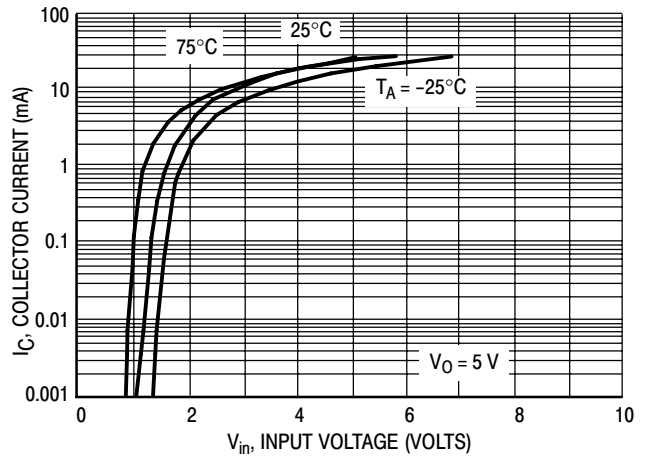

Figure 15. Output Current versus Input Voltage

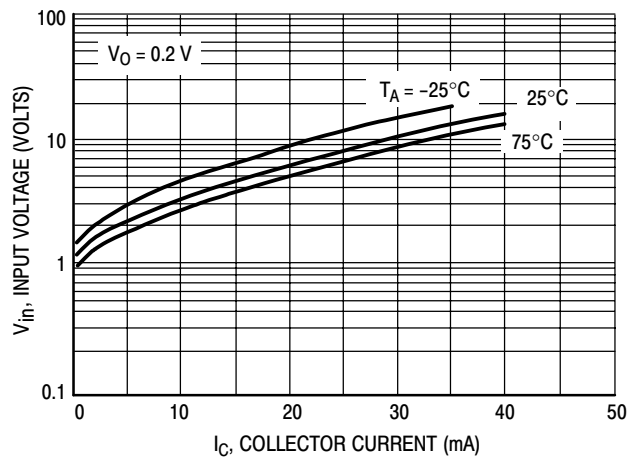

Figure 16. Input Voltage versus Output Current

MUN5211DW1T1 Series

TYPICAL ELECTRICAL CHARACTERISTICS — MUN5214DW1T1

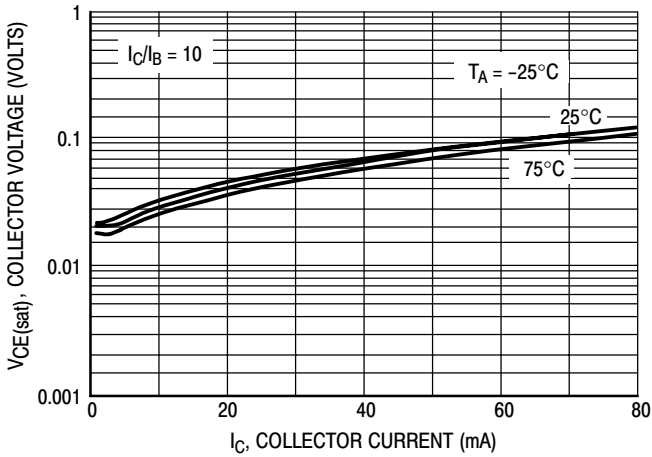

Figure 17. $V_{CE(sat)}$ versus I_C

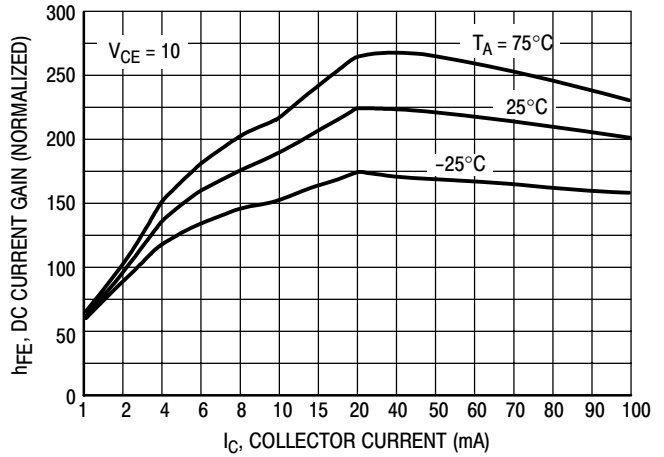

Figure 18. DC Current Gain

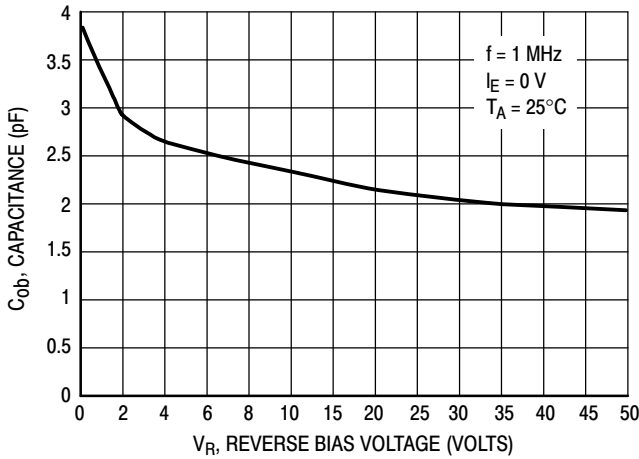

Figure 19. Output Capacitance

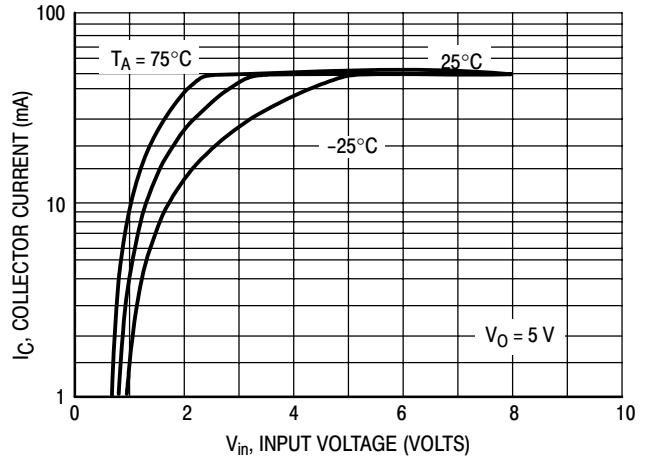

Figure 20. Output Current versus Input Voltage

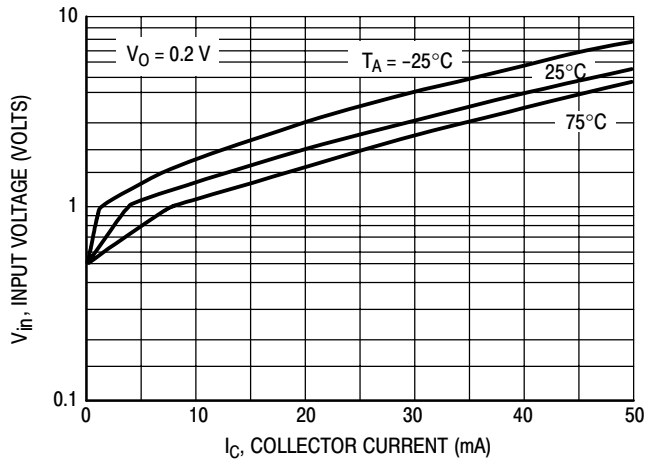

Figure 21. Input Voltage versus Output Current

MUN5211DW1T1 Series

TYPICAL ELECTRICAL CHARACTERISTICS — MUN5215DW1T1

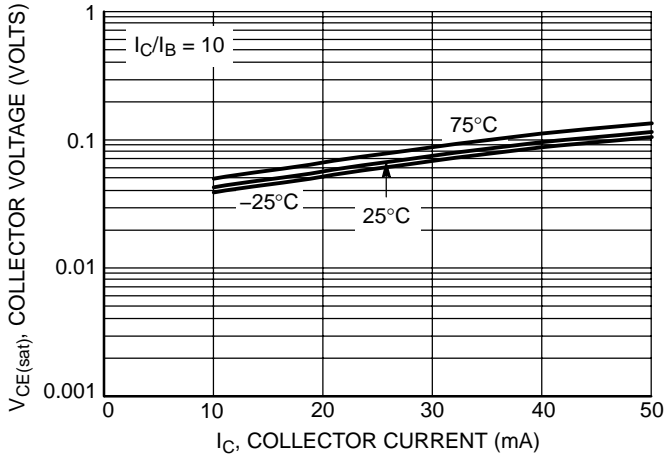

Figure 22. $V_{CE(sat)}$ versus I_C

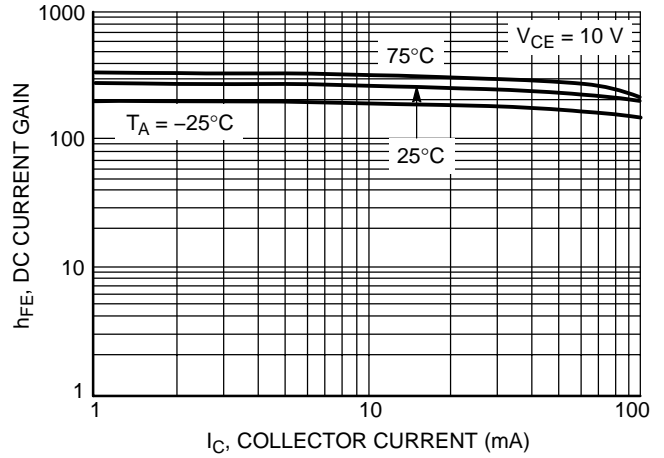

Figure 23. DC Current Gain

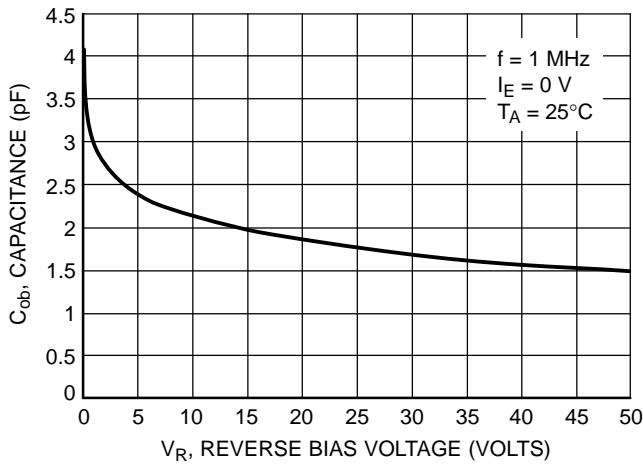

Figure 24. Output Capacitance

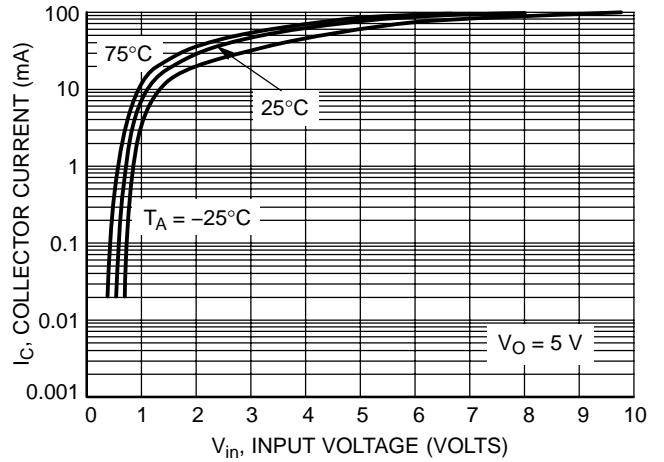

Figure 25. Output Current versus Input Voltage

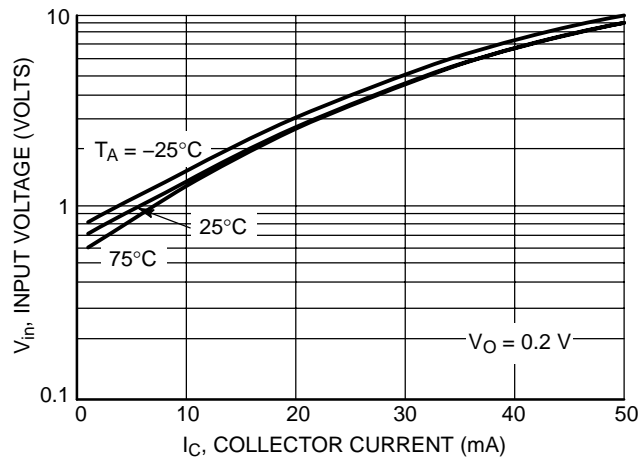

Figure 26. Input Voltage versus Output Current

MUN5211DW1T1 Series

TYPICAL ELECTRICAL CHARACTERISTICS — MUN5216DW1T1

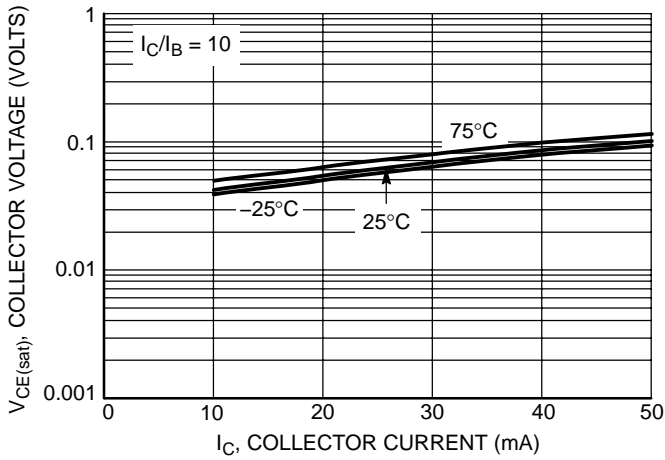

Figure 27. $V_{CE(sat)}$ versus I_C

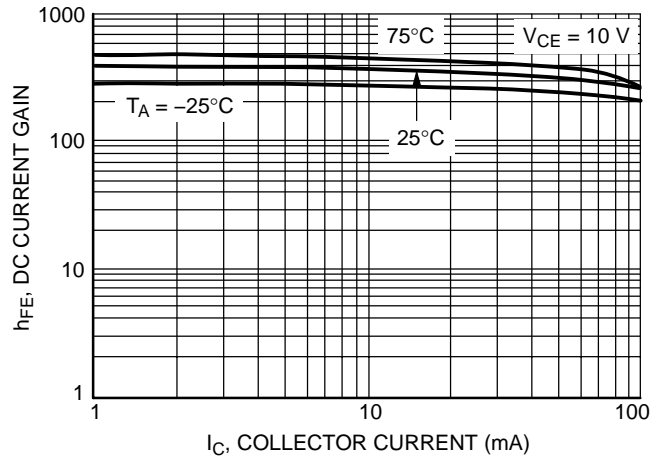

Figure 28. DC Current Gain

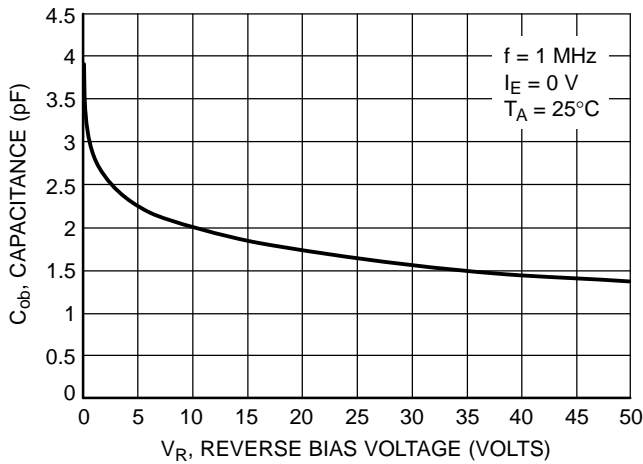

Figure 29. Output Capacitance

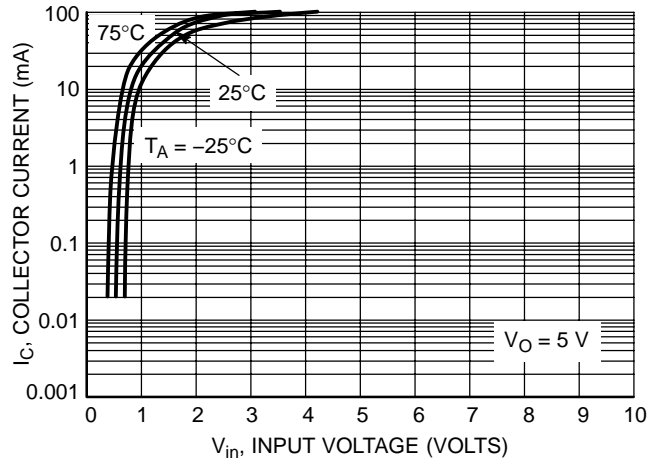

Figure 30. Output Current versus Input Voltage

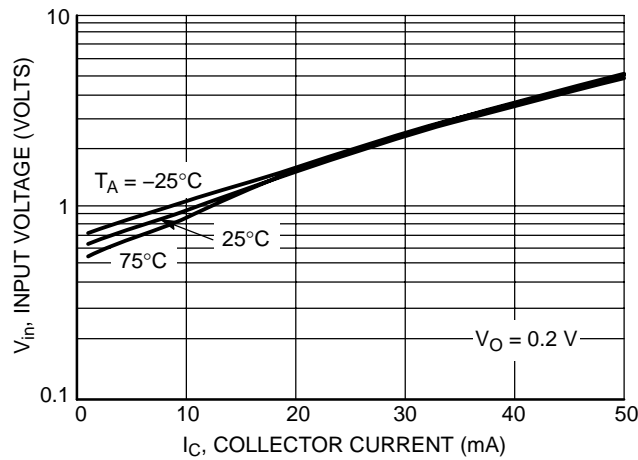

Figure 31. Input Voltage versus Output Current

MUN5211DW1T1 Series

TYPICAL ELECTRICAL CHARACTERISTICS — MUN5230DW1T1

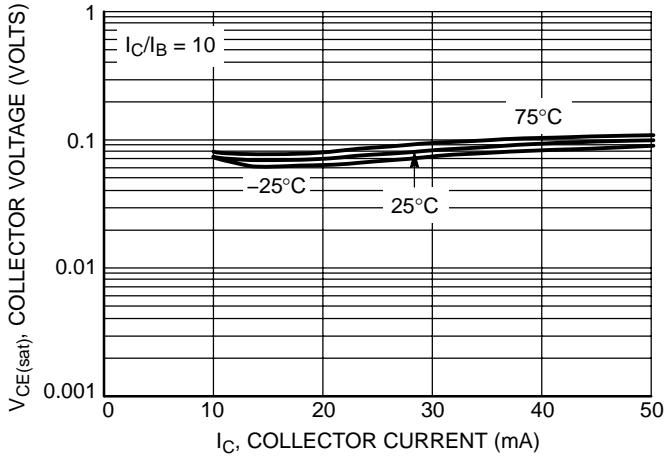

Figure 32. $V_{CE(sat)}$ versus I_C

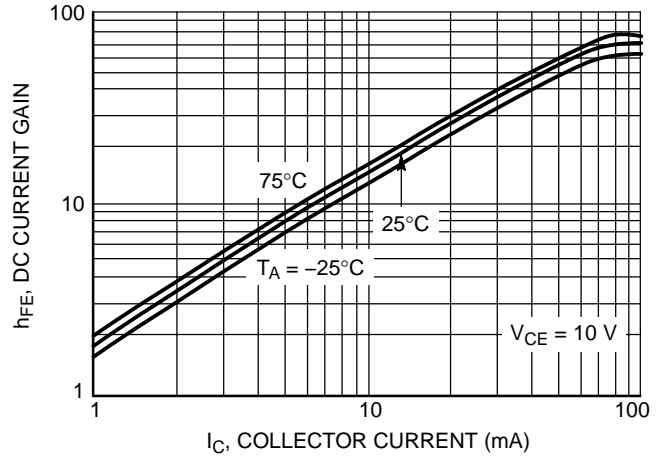

Figure 33. DC Current Gain

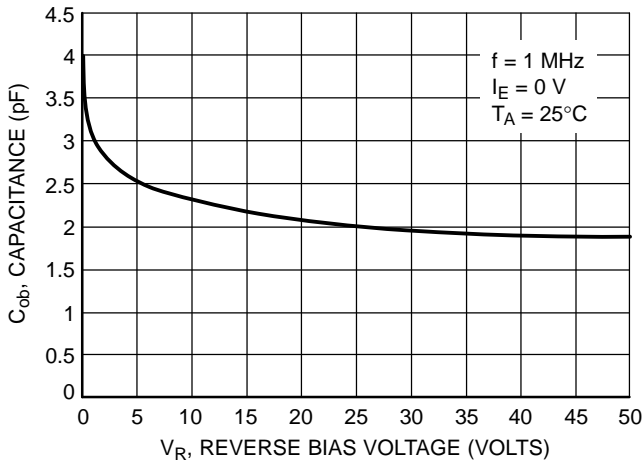

Figure 34. Output Capacitance

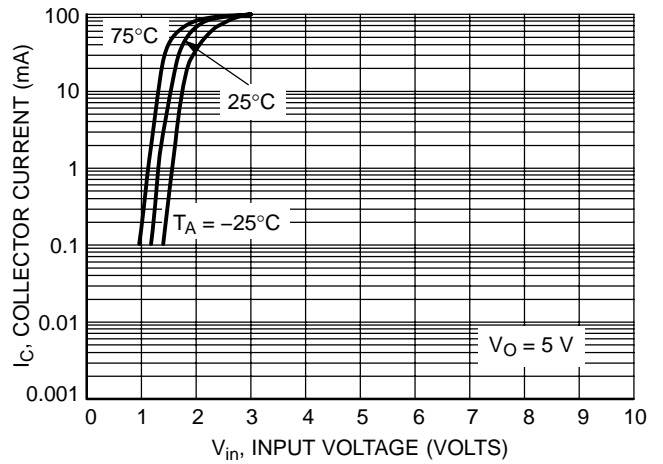

Figure 35. Output Current versus Input Voltage

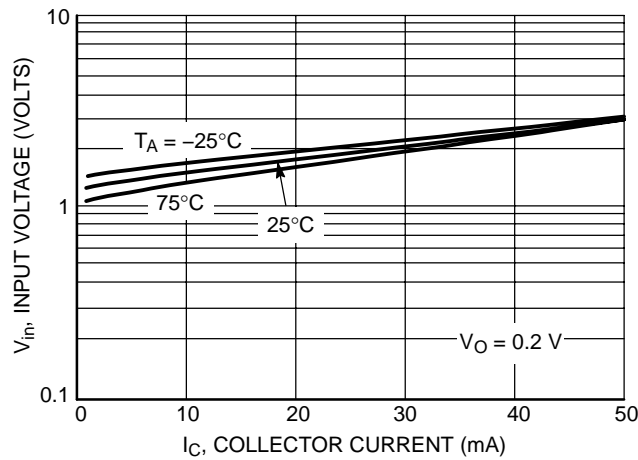

Figure 36. Input Voltage versus Output Current

MUN5211DW1T1 Series

TYPICAL ELECTRICAL CHARACTERISTICS — MUN5231DW1T1

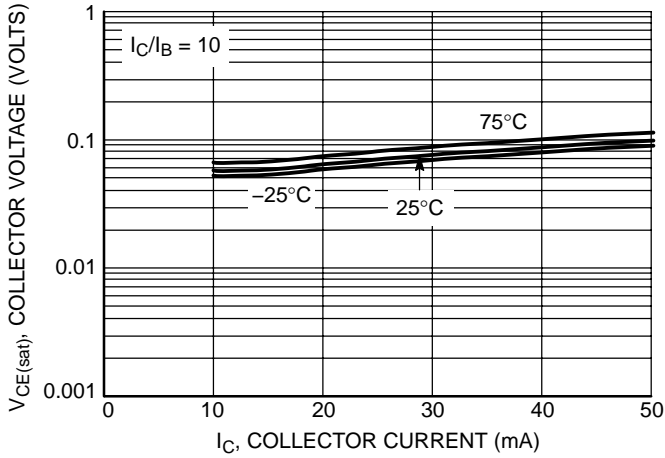

Figure 37. $V_{CE(sat)}$ versus I_C

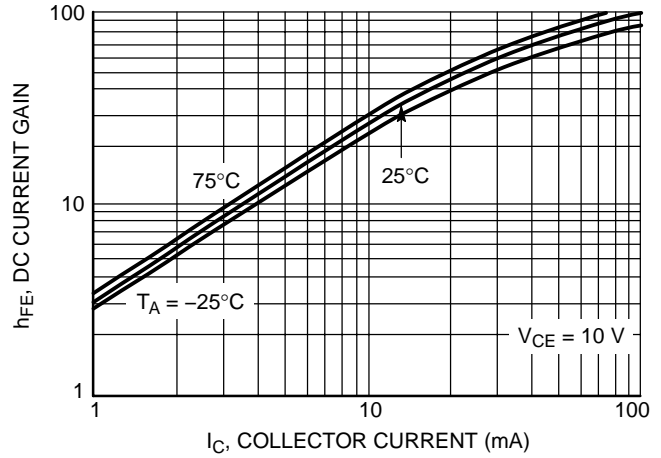

Figure 38. DC Current Gain

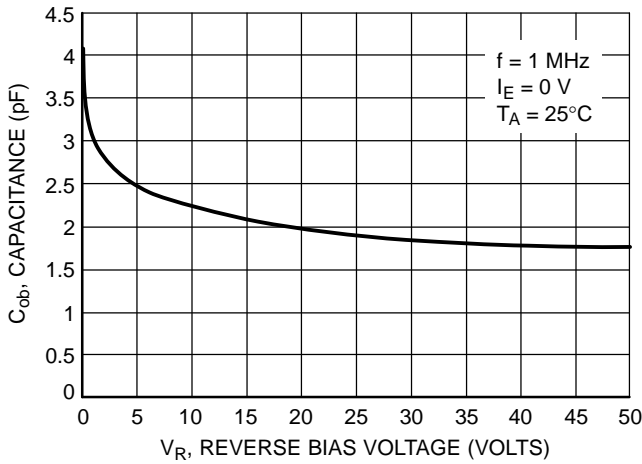

Figure 39. Output Capacitance

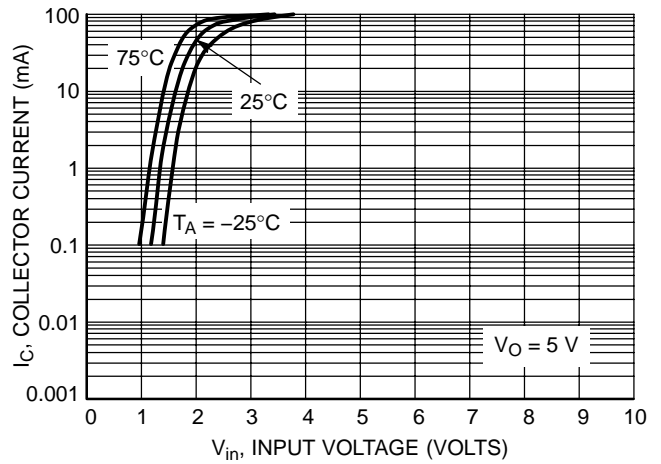

Figure 40. Output Current versus Input Voltage

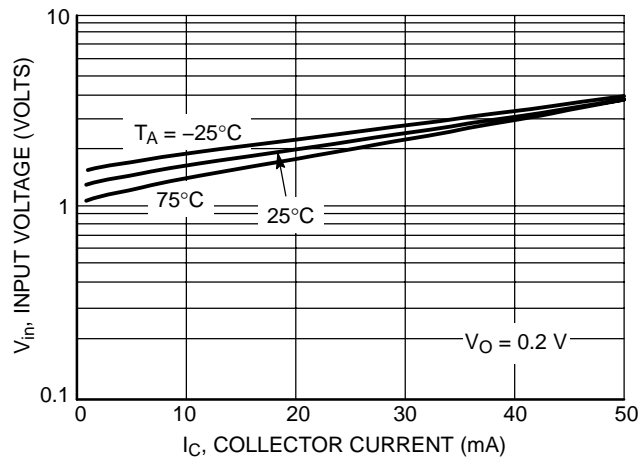

Figure 41. Input Voltage versus Output Current

MUN5211DW1T1 Series

TYPICAL ELECTRICAL CHARACTERISTICS — MUN5232DW1T1

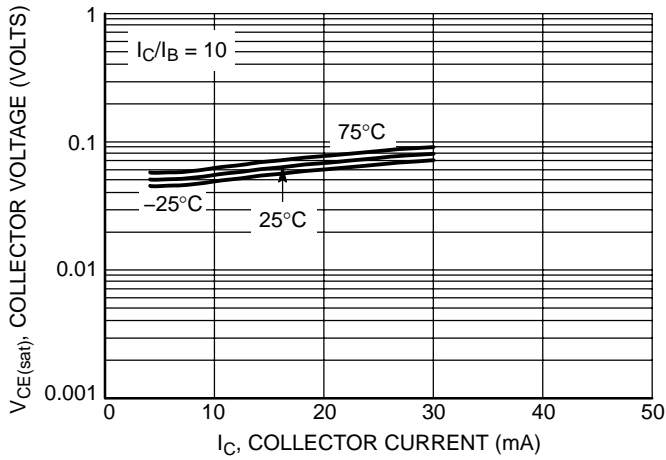

Figure 42. $V_{CE(sat)}$ versus I_C

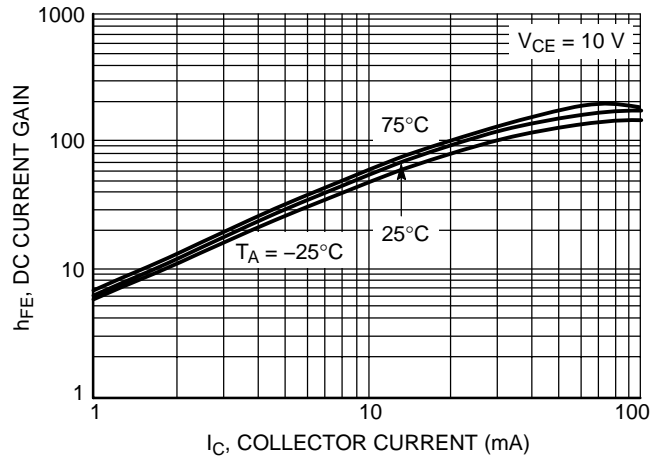

Figure 43. DC Current Gain

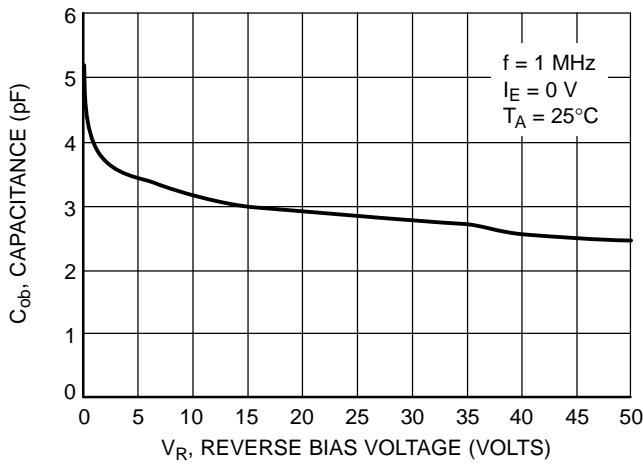

Figure 44. Output Capacitance

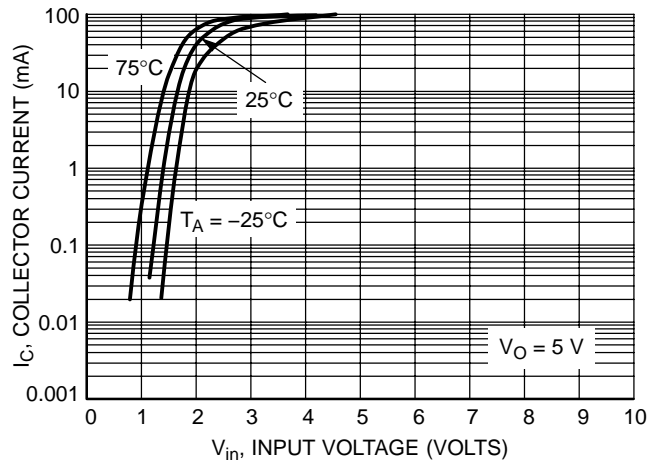

Figure 45. Output Current versus Input Voltage

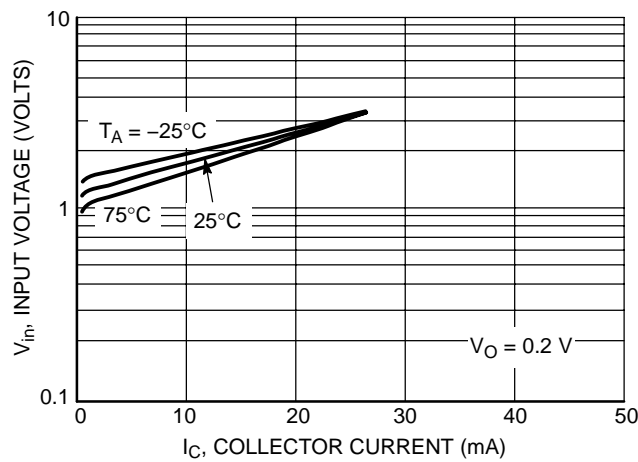

Figure 46. Input Voltage versus Output Current

MUN5211DW1T1 Series

TYPICAL ELECTRICAL CHARACTERISTICS — MUN5233DW1T1

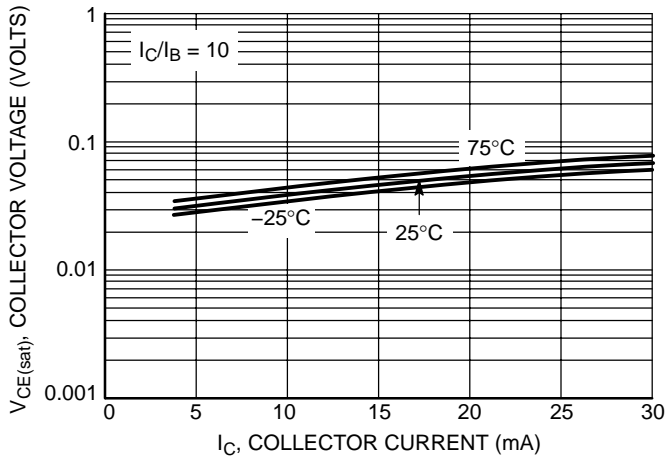

Figure 47. $V_{CE(sat)}$ versus I_C

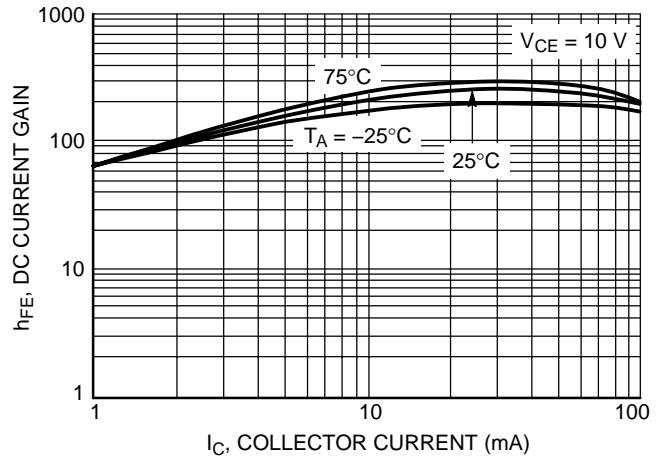

Figure 48. DC Current Gain

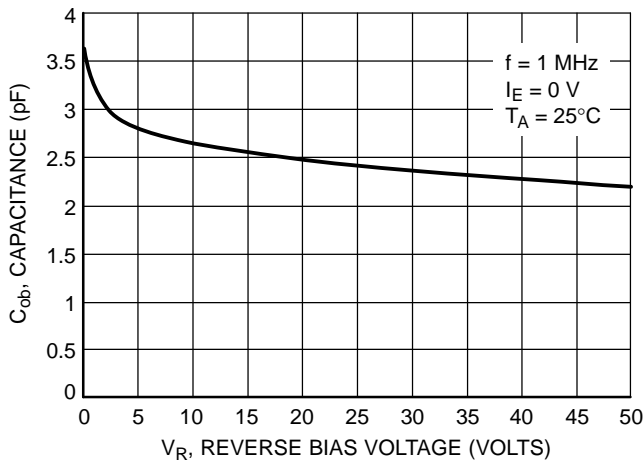

Figure 49. Output Capacitance

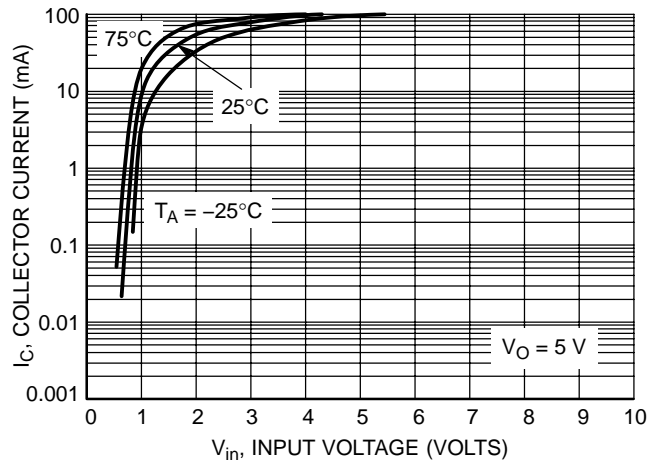

Figure 50. Output Current versus Input Voltage

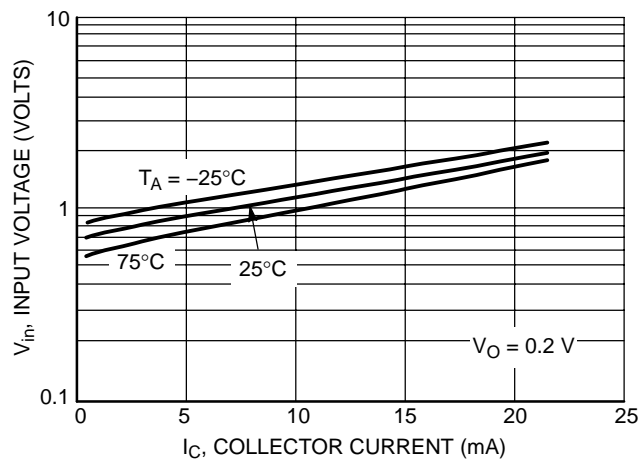

Figure 51. Input Voltage versus Output Current

MUN5211DW1T1 Series

TYPICAL ELECTRICAL CHARACTERISTICS — MUN5234DW1T1

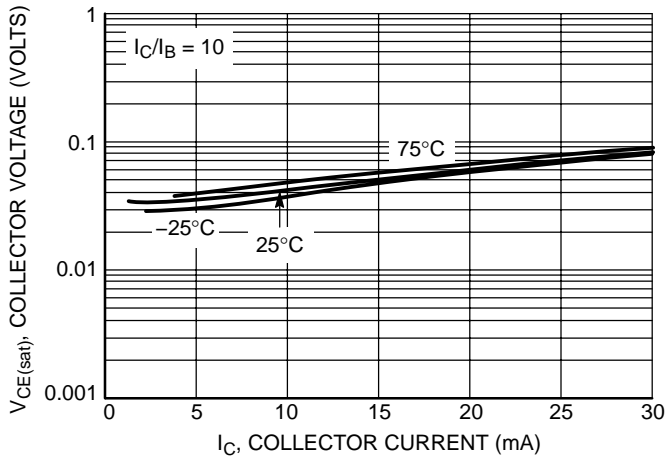

Figure 52. $V_{CE(sat)}$ versus I_C

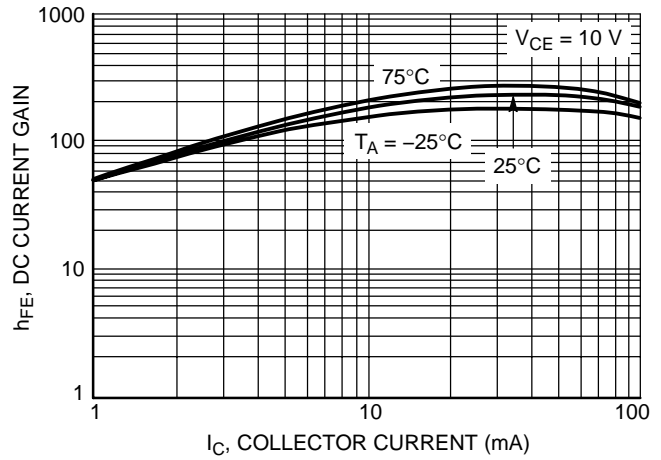
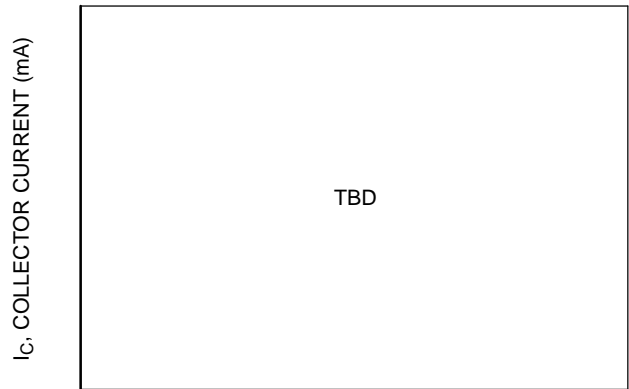

Figure 53. DC Current Gain



V_R , REVERSE BIAS VOLTAGE (VOLTS)

Figure 54. Output Capacitance



V_{in} , INPUT VOLTAGE (VOLTS)

Figure 55. Output Current versus Input Voltage

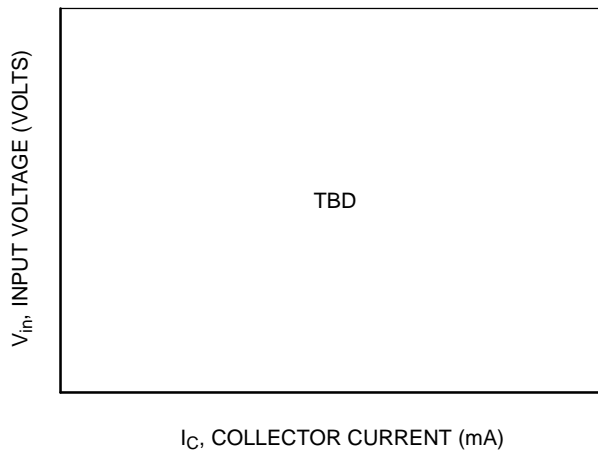

I_C , COLLECTOR CURRENT (mA)

Figure 56. Input Voltage versus Output Current

MUN5211DW1T1 Series

TYPICAL ELECTRICAL CHARACTERISTICS — MUN5235DW1T1

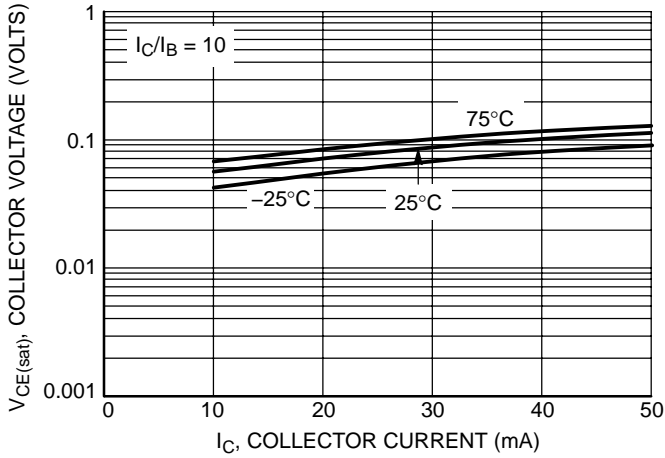

Figure 57. $V_{CE(sat)}$ versus I_C

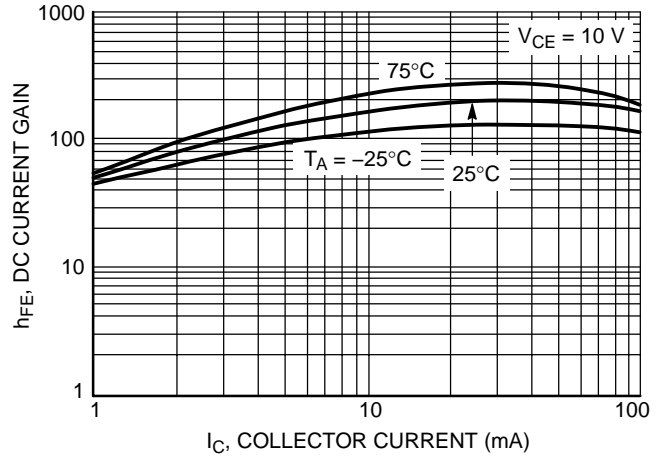

Figure 58. DC Current Gain

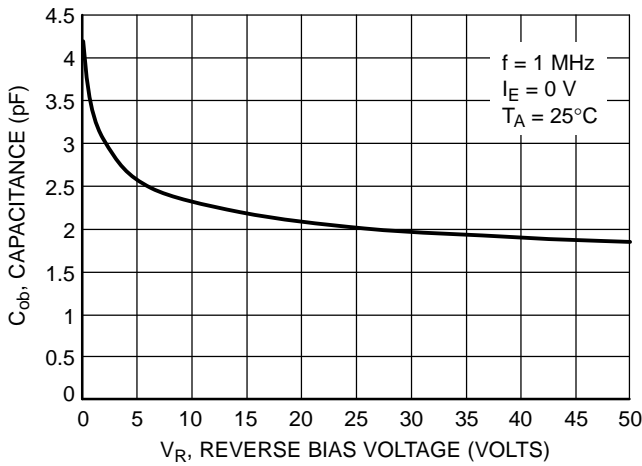

Figure 59. Output Capacitance

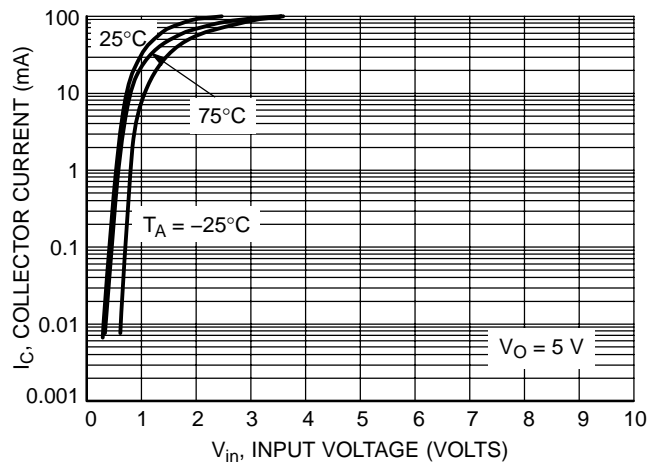

Figure 60. Output Current versus Input Voltage

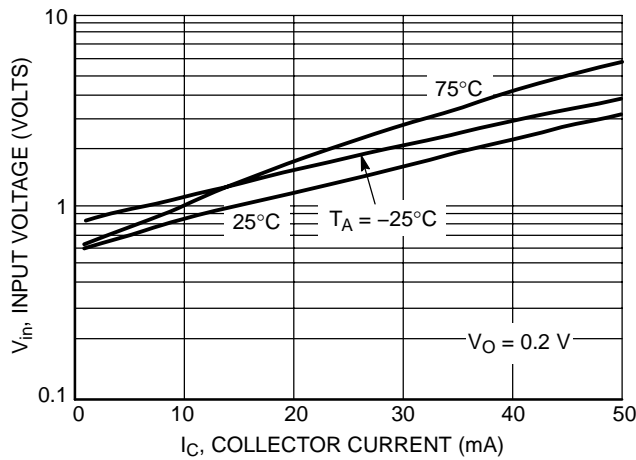

Figure 61. Input Voltage versus Output Current

MUN5211DW1T1 Series

TYPICAL ELECTRICAL CHARACTERISTICS — MUN5236DW1T1

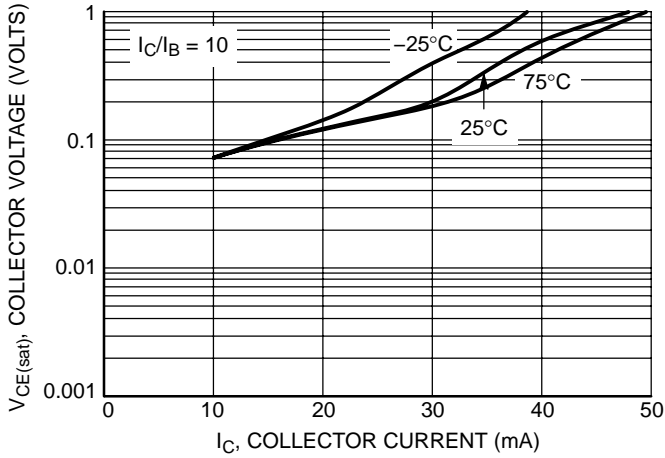

Figure 62. $V_{CE(sat)}$ versus I_C

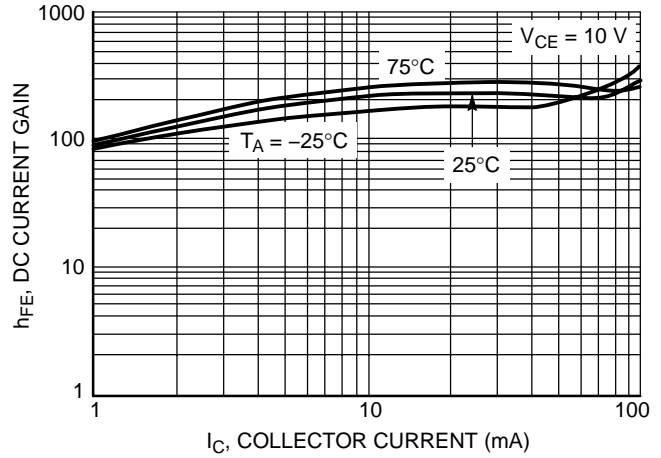

Figure 63. DC Current Gain

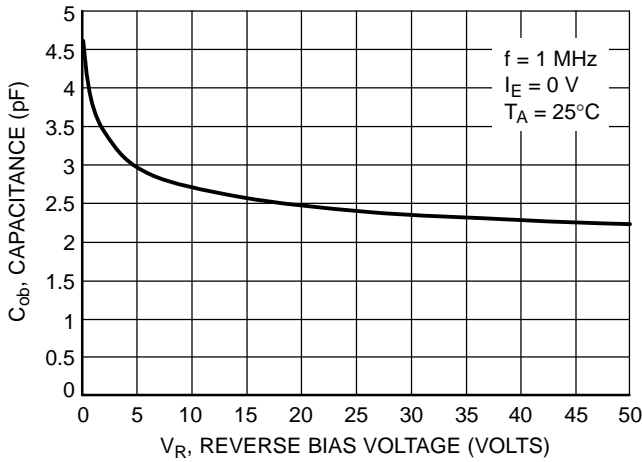

Figure 64. Output Capacitance

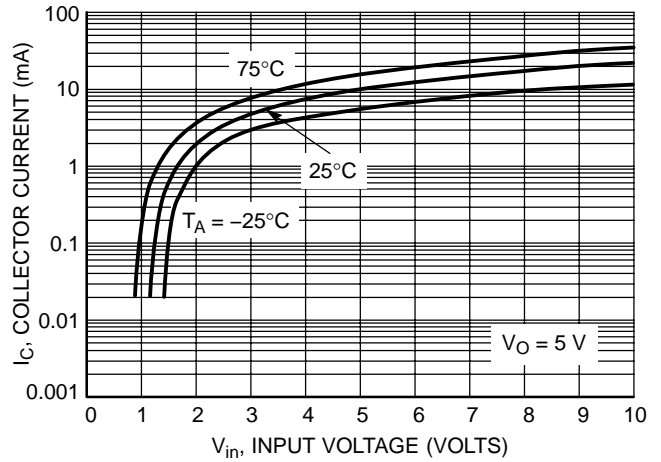

Figure 65. Output Current versus Input Voltage

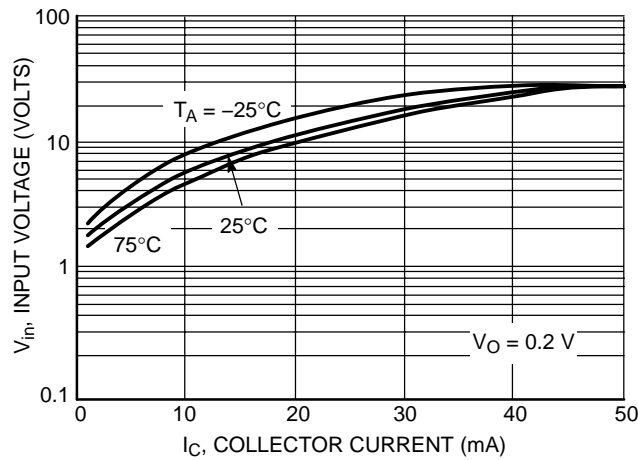

Figure 66. Input Voltage versus Output Current

MUN5211DW1T1 Series

TYPICAL ELECTRICAL CHARACTERISTICS — MUN5237DW1T1

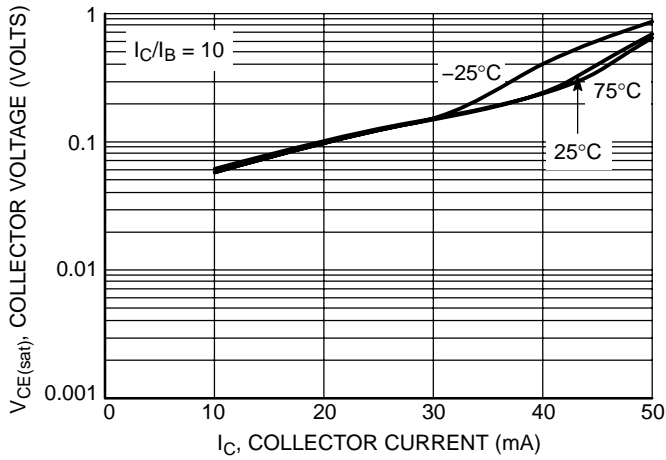

Figure 67. $V_{CE(sat)}$ versus I_C

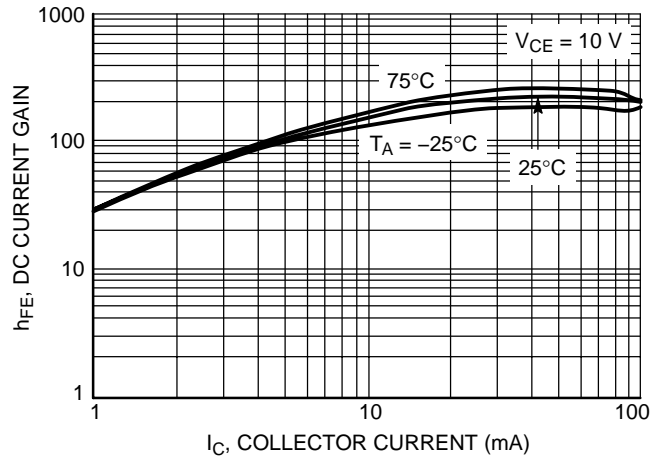

Figure 68. DC Current Gain

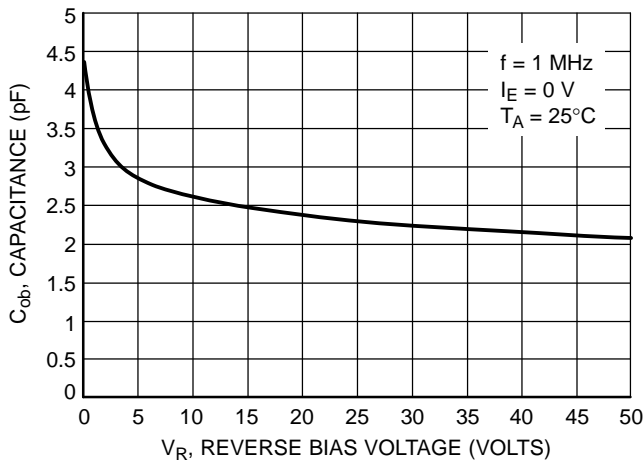

Figure 69. Output Capacitance

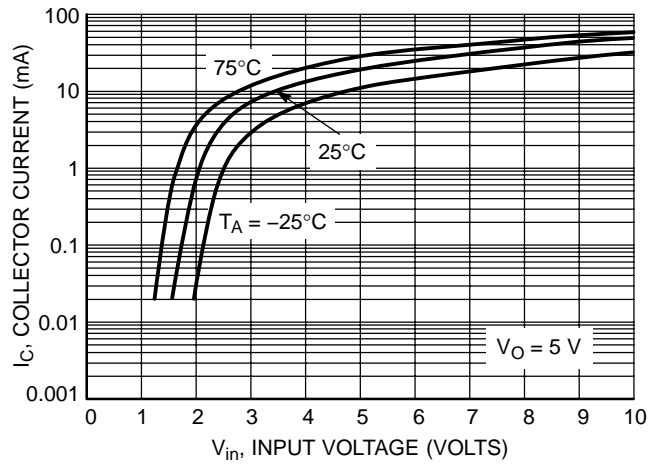

Figure 70. Output Current versus Input Voltage

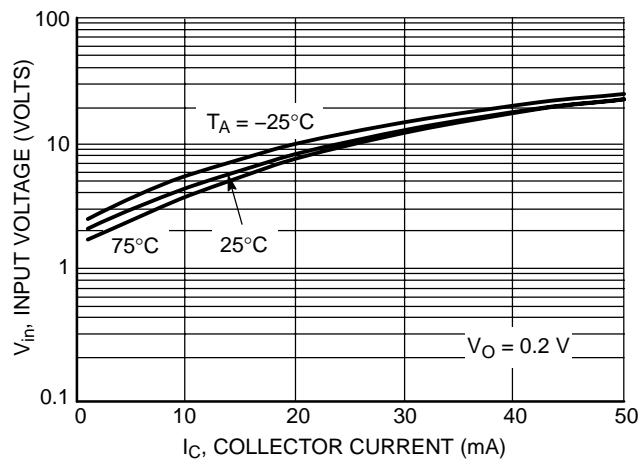
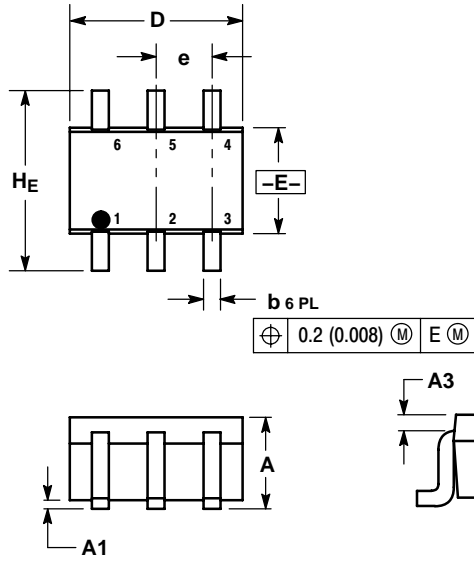

Figure 71. Input Voltage versus Output Current

MUN5211DW1T1 Series

PACKAGE DIMENSIONS

SC-88 (SOT-363)
CASE 419B-02
ISSUE V



- NOTES:
1. DIMENSIONING AND TOLERANCING PER ANSI Y14.5M, 1982.
 2. CONTROLLING DIMENSION: INCH.
 3. 419B-01 OBSOLETE, NEW STANDARD 419B-02.

DIM	MILLIMETERS			INCHES		
	MIN	NOM	MAX	MIN	NOM	MAX
A	0.80	0.95	1.10	0.031	0.037	0.043
A1	0.00	0.05	0.10	0.000	0.002	0.004
A3	0.20 REF			0.008 REF		
b	0.10	0.21	0.30	0.004	0.008	0.012
C	0.10	0.14	0.25	0.004	0.005	0.010
D	1.80	2.00	2.20	0.070	0.078	0.086
E	1.15	1.25	1.35	0.045	0.049	0.053
e	0.65 BSC			0.026 BSC		
L	0.10	0.20	0.30	0.004	0.008	0.012
HE	2.00	2.10	2.20	0.078	0.082	0.086

- STYLE 1:
- PIN 1. EMITTER 2
 - BASE 2
 - COLLECTOR 1
 - EMITTER 1
 - BASE 1
 - COLLECTOR 2

SOLDERING FOOTPRINT*

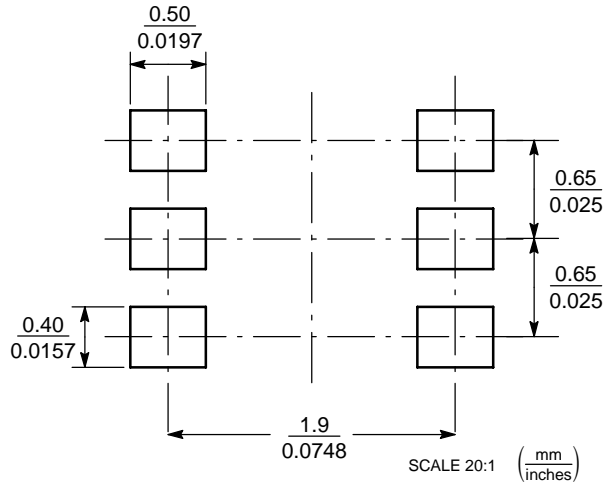

*For additional information on our Pb-Free strategy and soldering details, please download the ON Semiconductor Soldering and Mounting Techniques Reference Manual, SOLDERRM/D.

MUN5211DW1T1 Series

ON Semiconductor and **ON** are registered trademarks of Semiconductor Components Industries, LLC (SCILLC). SCILLC reserves the right to make changes without further notice to any products herein. SCILLC makes no warranty, representation or guarantee regarding the suitability of its products for any particular purpose, nor does SCILLC assume any liability arising out of the application or use of any product or circuit, and specifically disclaims any and all liability, including without limitation special, consequential or incidental damages. "Typical" parameters which may be provided in SCILLC data sheets and/or specifications can and do vary in different applications and actual performance may vary over time. All operating parameters, including "Typicals" must be validated for each customer application by customer's technical experts. SCILLC does not convey any license under its patent rights nor the rights of others. SCILLC products are not designed, intended, or authorized for use as components in systems intended for surgical implant into the body, or other applications intended to support or sustain life, or for any other application in which the failure of the SCILLC product could create a situation where personal injury or death may occur. Should Buyer purchase or use SCILLC products for any such unintended or unauthorized application, Buyer shall indemnify and hold SCILLC and its officers, employees, subsidiaries, affiliates, and distributors harmless against all claims, costs, damages, and expenses, and reasonable attorney fees arising out of, directly or indirectly, any claim of personal injury or death associated with such unintended or unauthorized use, even if such claim alleges that SCILLC was negligent regarding the design or manufacture of the part. SCILLC is an Equal Opportunity/Affirmative Action Employer. This literature is subject to all applicable copyright laws and is not for resale in any manner.

PUBLICATION ORDERING INFORMATION

LITERATURE FULFILLMENT:

Literature Distribution Center for ON Semiconductor
P.O. Box 61312, Phoenix, Arizona 85082-1312 USA
Phone: 480-829-7710 or 800-344-3860 Toll Free USA/Canada
Fax: 480-829-7709 or 800-344-3867 Toll Free USA/Canada
Email: orderlit@onsemi.com

N. American Technical Support: 800-282-9855 Toll Free
USA/Canada

Japan: ON Semiconductor, Japan Customer Focus Center
2-9-1 Kamimeguro, Meguro-ku, Tokyo, Japan 153-0051
Phone: 81-3-5773-3850

ON Semiconductor Website: <http://onsemi.com>

Order Literature: <http://www.onsemi.com/litorder>

For additional information, please contact your
local Sales Representative.

MUN5211DW1T1/D